

Article number: 2310309521ESD

Description: E+G Antistatic base for levelling elements
LV.A-100-24-AS-M16x58-ESD-C

Measures

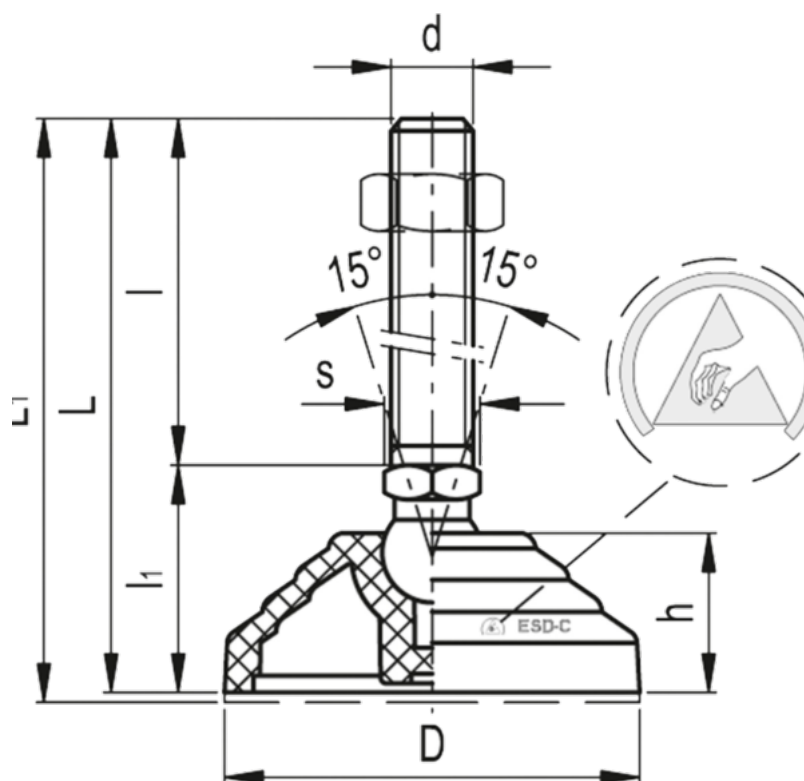

Articulation	= 24	Max load	= 25000
D	= 100	s	= 24
d	= M16	Weight in (g)	= 305
h	= 24		
l	= 58		
l1	= 43		
L	= 101		
L1	= 104		